

MAKE SHARP EDGE ALWAYS IN REACH



四川神工钨钢刀具有限公司
SICHUAN SHEN GONG CARBIDE KNIVES CO., LTD.

SICHUAN SHEN GONG CARBIDE KNIVES CO. LTD.

Address: 3119 Airport 3rd road, Southwest airport economic development zone,
Shuangliu district, Chengdu, Sichuan Province, China. 610207.

Tel: 0086-28-85750909

Fax: 0086-28-87980610

Website: www.sgknives.com

EXPERT IN CARBIDE INDUSTRIAL KNIVES

ISO 9001 CERTIFIED ENTERPRISE

SICHUAN SHEN GONG CARBIDE KNIVES CO., LTD

PRESIDENT'S MESSAGE

Dear Partners, Industry Colleagues, and Friends Who Support the Development of Sichuan Shen Gong:

Over the past two decades, we have journeyed through challenges and opportunities, growing from a small workshop with just over a dozen employees and a few outdated grinding machines into a comprehensive enterprise specializing in the research, development, production, and sales of carbide industrial slitting knives and blades across numerous industries. Throughout this journey, we have steadfastly adhered to one belief: to provide professional, reliable, and durable carbide industrial knives to various sectors.

In the wave of modern industrial production, carbide industrial knives and blades, with their outstanding performance and broad applicability, have become indispensable in many industries. Our products, renowned for their exceptional wear resistance and highly stable quality, are widely used not only in the packaging industry but also in fields such as new energy lithium-ion batteries, chemical fibers, plastics, sheet metal, medical devices, and food processing, enhancing quality and efficiency in our customers' production. Whether it's slitting, shredding, or cutting, Shen Gong knives have earned the trust and favor of users across industries for their excellent processing quality and high cost-effectiveness.

We are keenly aware that quality is the lifeline of an enterprise. Therefore, from the selection of raw materials to the control of the production process, and finally to the inspection of finished products, we strive for excellence in every step, ensuring that each product meets or even exceeds customer expectations. It is this relentless pursuit of quality that has earned our products widespread recognition in both domestic and international markets, with overseas business accounting for more than half of our total sales.

Moving forward, we will continue to uphold our product philosophy of "pursuing excellence and striving for progress." We will keep pace with the times to provide more outstanding Shen Gong products to our customers across various industries.

On behalf of all employees of Sichuan Shen Gong, I would like to express our heartfelt thanks for your long-standing trust and support. We look forward to working hand in hand with you to create a brighter future together.

SHEN GONG, Make sharp edge always in reach!



黄鸿春
HONGCHUN HUANG
President & Founder

黄鸿春

CONTENTS

SICHUAN SHEN GONG CARBIDE KNIVES CO., LTD	01	KNIVES & PARTS FOR CORRUGATED INDUSTRY	20
COMPANY PROFILE	03	KNIVES FOR PACKAGING/PRINTING/PAPER PROCESSING INDUSTRIES	22
HONOR & CERTIFICATION	04	KNIVES & PARTS FOR LI-ION BATTERY INDUSTRY	27
CORPORATE ENVIRONMENT	05	KNIVES FOR METAL SHEET AND FOIL INDUSTRIES	29
PRODUCTION OVERVIEW	07	KNIVES FOR RUBBER&PLASTIC AND RECYCLING INDUSTRIES	32
HISTORY & DEVELOPMENT	09	KNIVES FOR CHEMICAL FIBER & NON-WOVEN FABRIC INDUSTRIES	35
GLOBAL BUSINESS	11	KNIVES FOR FOOD PROCESSING	36
APPLICATIONS OF PRODUCTS	13	KNIVES FOR MEDICAL INDUSTRY	37
MANUFACTURING PROCESS	15	CERMET CUTTING TOOLS	38
MATERIALS MANUFACTURING TECHNOLOGY	17	CARBIDE BLANKS	40
PRECISION PROCESSING TECHNOLOGY	18	OTHER CUSTOMIZED PRODUCTS	41
GRADES INTRODUCTION & PHYSICAL PROPERTIES	19	OUR SERVICE	42



COMPANY PROFILE

COMPANY AND BUSINESS OVERVIEW

Founded in 1998 by Mr. Huang Hongchun, the president, Sichuan Shen Gong Carbide Knives Co., Ltd. (following abbreviation is "Shen Gong") is currently located in, Chengdu, Sichuan Province China.

Shen Gong is a national high-tech enterprise that specializes in the research, development, manufacturing, and sales of carbide industrial tools. With a registered capital of 135 million RMB, the company employs over 300 people and operates across 2 manufacturing bases totaling with 46,667 square meters.

Shen Gong has complete production lines for WC-based carbide and TiCN-based cermet materials, from RTP powder preparation to finished industrial knives and blades. The company possesses full independent research and development capabilities for both materials and geometry design. Equipped with more than 600 advanced production and inspection equipment, including industry-leading imported high-precision automated equipment, Shen Gong ensures top-tier quality and efficiency.

The company's main products include carbide and cermet slitting knives, cutting blades, shredding blades, cutting tools, wear-resistant parts, and related accessories. These products are widely used in over ten industries and fields, such as corrugated cardboard, new energy lithium-ion batteries, packaging, rubber and plastics, metal processing, paper printing, non-woven fabrics, chemical fibers, food, and medical. More than half of the products are exported to over 40 countries and regions worldwide, with many clients being Fortune 500 companies.

Whether it's product customization or solution provision, Shen Gong is your reliable partner in the field of industrial knives and blades.

HONOR & CERTIFICATION

ISO CERTIFIED MANUFACTURING



WITH OVER 40 PATENTS
TECHNICIANS COMPRISES MEMBERS FROM RENOWNED UNIVERSITIES BOTH DOMESTICALLY AND INTERNATIONALLY;
AND FULLY INTRODUCED JAPANESE CARBIDE & CERMET PRODUCTION TECHNOLOGY AND PROCESSES.

SOME PATENTS OF SHEN GONG

- A lower knife cutting mechanism and cutting device for the new energy industry
- An upper knife cutting mechanism and cutting device for the new energy industry
- Large-scale polishing machine
- Linkage rotary table grinding machine
- A blade adjustment mechanism and battery cutting device
- A TiCN-based fine-grained cermet cutting tool and its preparation method
- A flatness detection device for circular blades
- Four-axis linkage automatic grinding machine
- Automatic feed device for machine tools
- ...

CORPORATE ENVIRONMENT



FACTORY AERIAL VIEW



EMPLOYEE LIVING AREA



OFFICE AREA



COMPANY MAIN ENTRANCE



COMPANY LOBBY

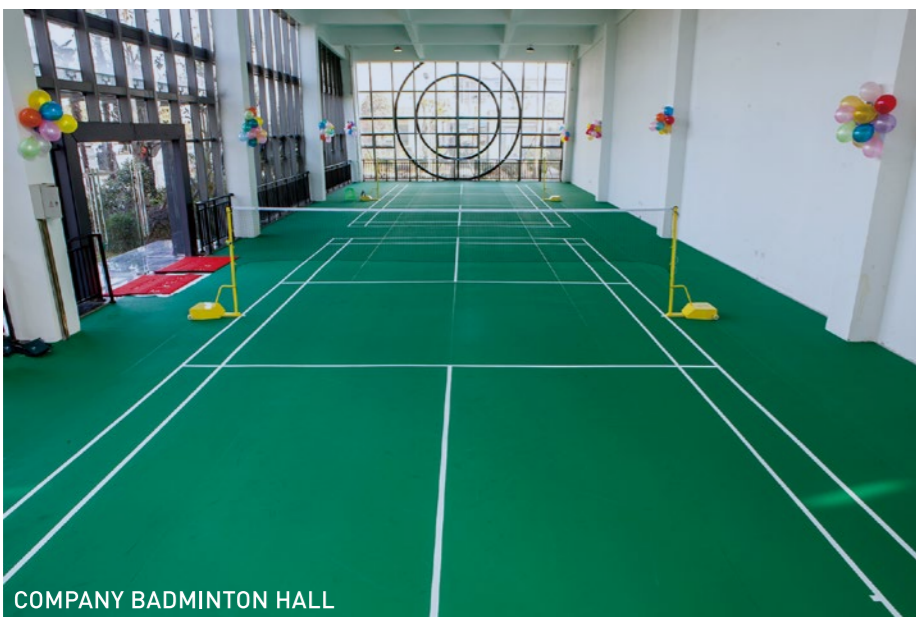

COMPANY BADMINTON HALL



COMPANY EXHIBITION HALL

PRODUCTION OVERVIEW



HISTORY & DEVELOPMENT

OVER **20** YEARS
EXPERT IN CARBIDE INDUSTRIAL KNIVES AND BLADES

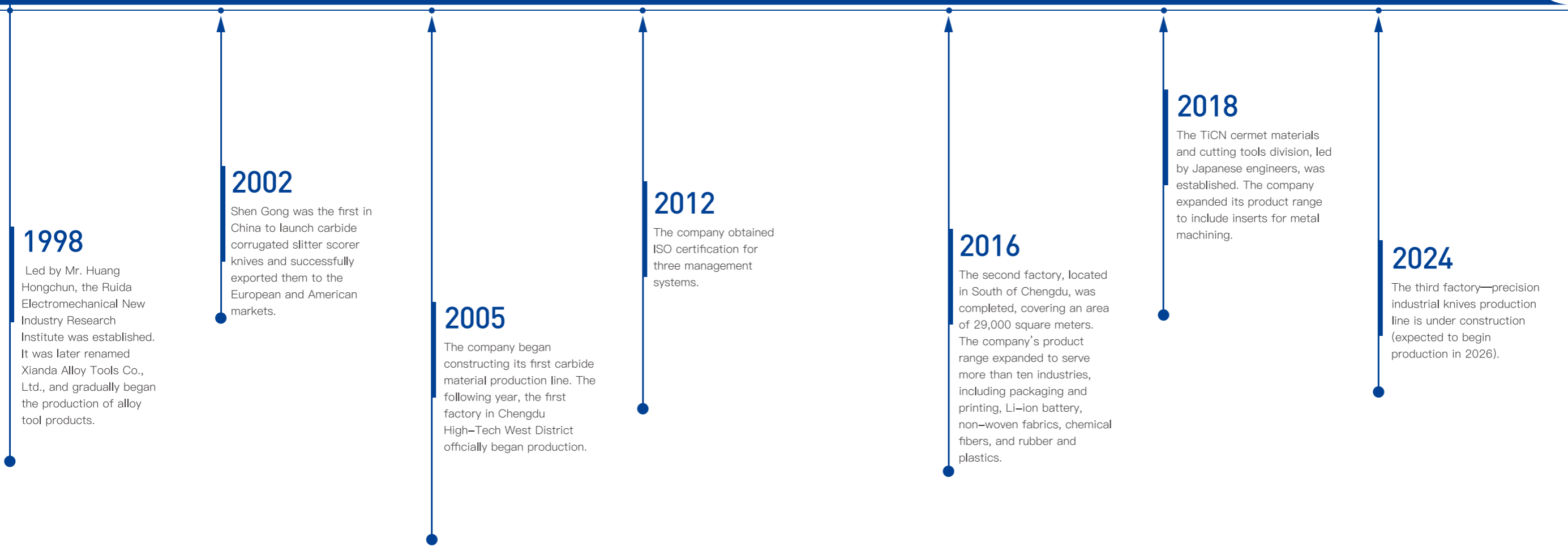
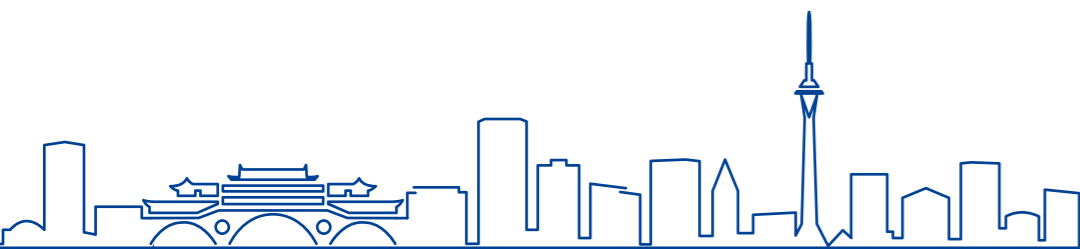

1998
Led by Mr. Huang Hongchun, the Ruida Electromechanical New Industry Research Institute was established. It was later renamed Xianda Alloy Tools Co., Ltd., and gradually began the production of alloy tool products.

2002
Shen Gong was the first in China to launch carbide corrugated slitter scorer knives and successfully exported them to the European and American markets.

2005
The company began constructing its first carbide material production line. The following year, the first factory in Chengdu High-Tech West District officially began production.

2012
The company obtained ISO certification for three management systems.

2016
The second factory, located in South of Chengdu, was completed, covering an area of 29,000 square meters. The company's product range expanded to serve more than ten industries, including packaging and printing, Li-ion battery, non-woven fabrics, chemical fibers, and rubber and plastics.

2018
The TiCN cermet materials and cutting tools division, led by Japanese engineers, was established. The company expanded its product range to include inserts for metal machining.

2024
The third factory—precision industrial knives production line is under construction (expected to begin production in 2026).

GLOBAL BUSINESS

MAIN OVERSEAS BUSINESS REGIONS:
Europe / Asia / North America



20+ YEARS OF OVERSEAS BUSINESS

40+ COUNTRIES AND REGIONS EXPORTED

10+ INDUSTRIES SERVED

1.5+ MILLION PIECES/YERA OF INDUSTRIAL KNIVES EXPORTED OVERSEAS



APPLICATIONS OF PRODUCTS



• Shen Gong supports the development of products for special application scenarios and provides solutions for industrial knives and blades.

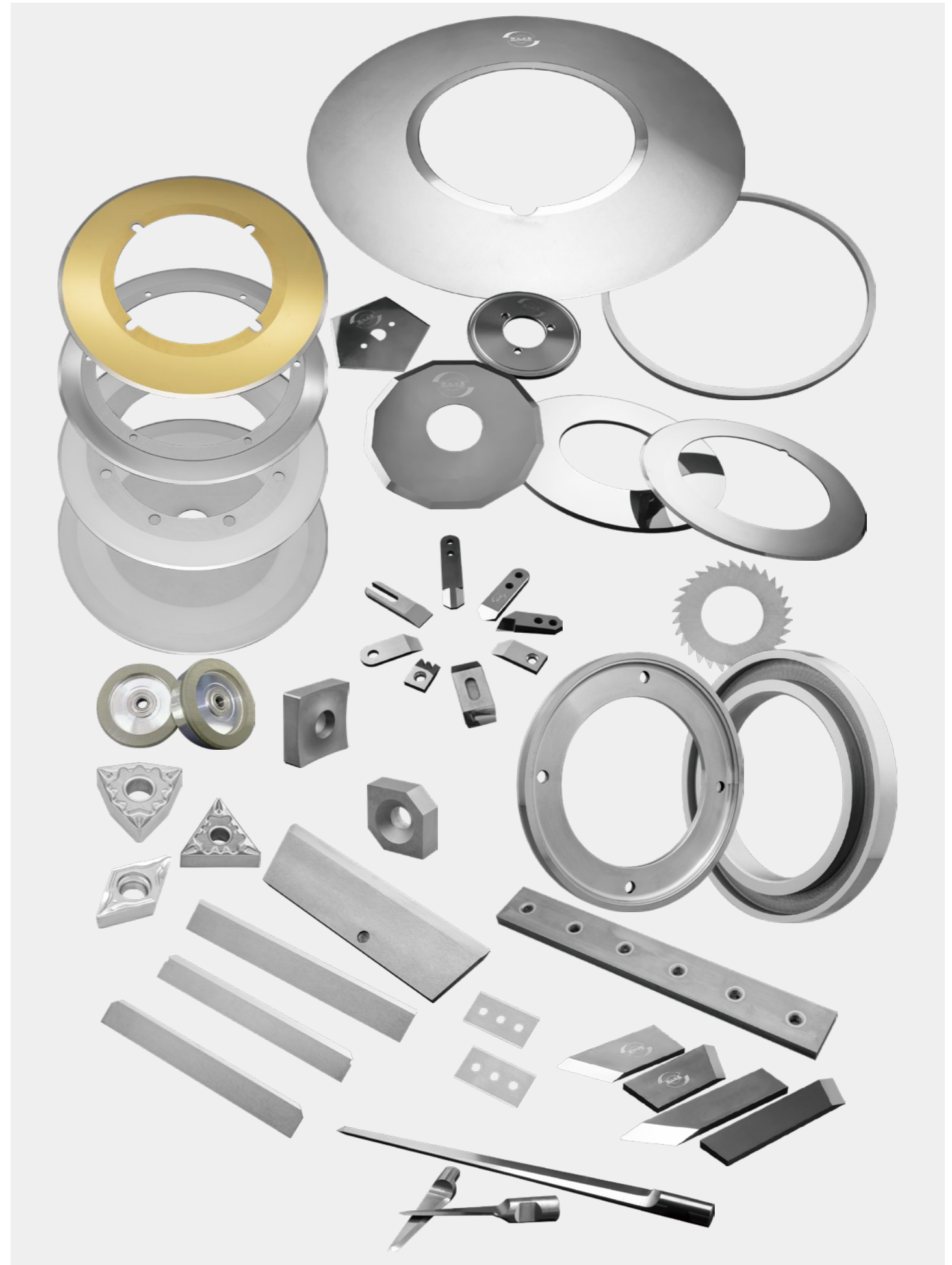

MANUFACTURING PROCESS

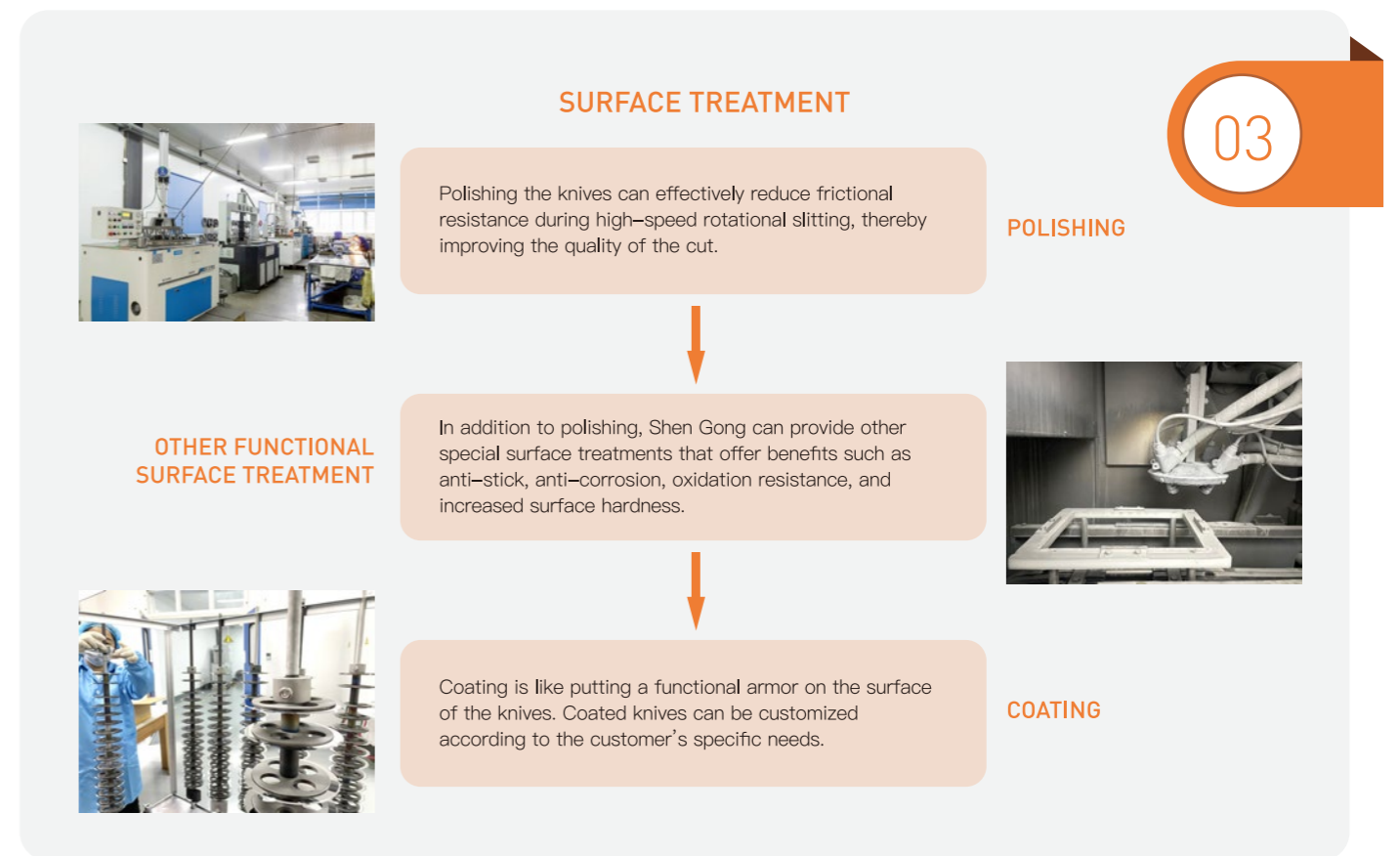
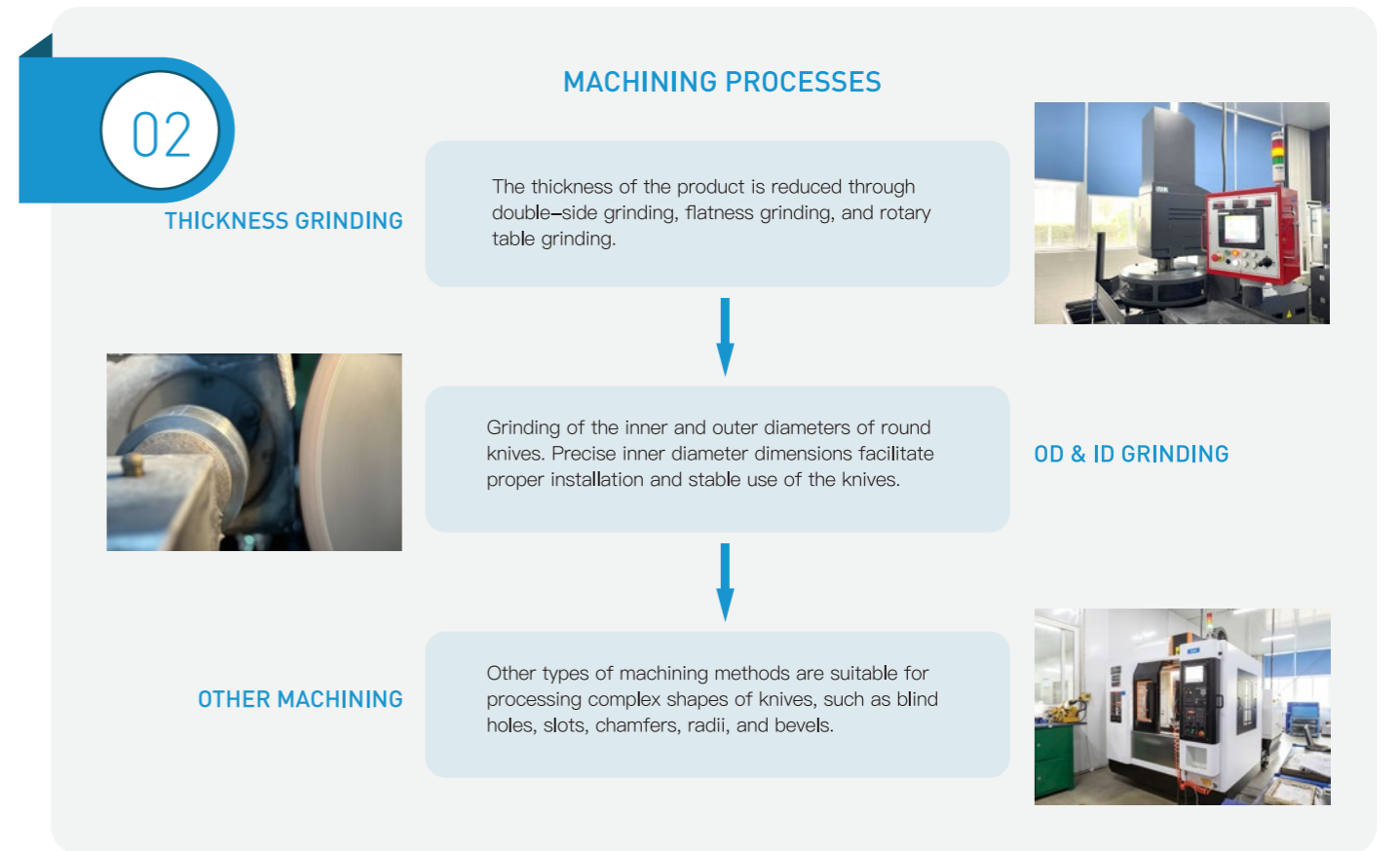

MATERIALS MANUFACTURING TECHNOLOGY

ULTRA-FINE CEMENTED CARBIDE

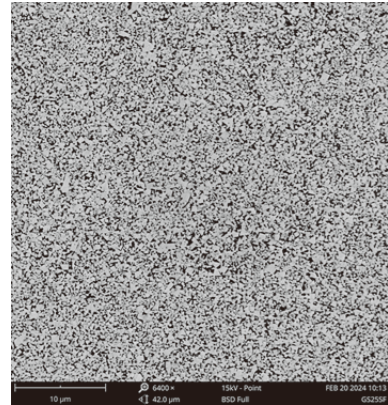

Shen Gong ultra-fine cemented carbide BEI x 6400

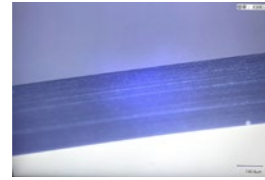

Cutting edge of Shen Gong ultra-fine carbide x300

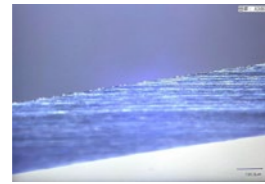

Cutting edge of regular fine carbide x300

- Utilizing 0.4-0.8 μm ultra-fine tungsten carbide effectively controls tip defects on precision blades, suppresses dust, and significantly enhances precision slitting performance, resulting in better cut quality.
- High hardness brings excellent durability, with HRA hardness reaching up to 93.5.
- The combination of good fracture toughness and flexural strength ensures more stable performance during blade use.

HIGH-STRENGTH CEMENTED CARBIDE

- Shen Gong's unique sintering process achieves a higher proportion of α -phase binder, effectively increasing transverse rupture strength (TRS) to up to 5000 MPa.
- Metallurgical control above industry standards results in a more dense and tough cemented carbide.



Shen Gong High-Strength Cemented Carbide Metallurgy x 200 A02B00C00



Regular Cemented Carbide Metallurgy x 200 A04B02C00

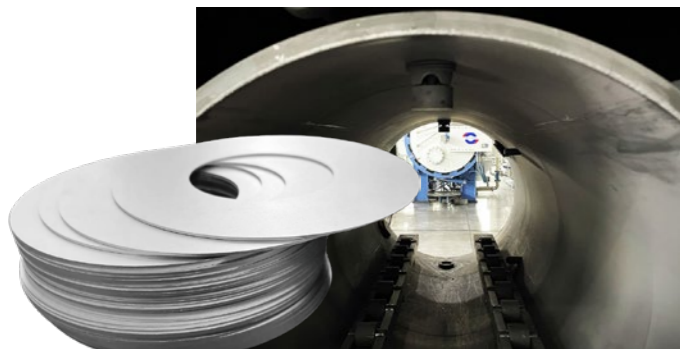

Shen Gong's unique sintering process ensures the production of high-strength cemented carbide materials.

MAJOR INSPECTION EQUIPMENT FOR MATERIAL



SCANNING ELECTRON MICROSCOPE (SEM)



CARBON ANALYZER



METALLURGICAL MICROSCOPE



DENSITOMETER



LASER PARTICLE SIZE ANALYZER



VICKERS HARDNESS TESTER(K1C AVAILABLE)



MOISTURE ANALYZER/ VISCOMETER



MAGNETIC MEASURING EQUIPMENT



UNIVERSAL TESTING MACHINE

PRECISION PROCESSING TECHNOLOGY

DIGITALIZED AND STANDARDIZED PRODUCTION

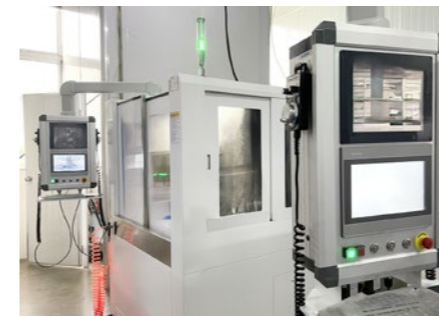

- Shen Gong extensively utilizes CNC and automated processing equipment in its production facilities, with some key processes employing world-leading imported equipment to effectively ensure batch quality stability.
- Shen Gong is equipped with a full range of industrial knife processing equipment, including grinding, milling, turning, drilling, wire cutting, polishing, and sandblasting machines.
- 6S on-site standard management.

PRECISION MACHINING

- Shen Gong's precision machining workshop operates under temperature-controlled conditions, effectively ensuring stability and consistency in product quality across batches.
- Shen Gong's precision machining technology ensures that the thickness, flatness, parallelism, and straightness of knives are controlled to the micron (μm) level. Surface roughness can reach below Ra0.02, achieving a full mirror finish.

Shen Gong's years of expertise in industrial knife edge grinding technology can control edge tip defects to the micron (μm) level.

High-precision special edge processing technology ensures knife sharpness while supporting 300x magnification or higher inspection for "zero defects."



MAJOR INSPECTION EQUIPMENT FOR MACHINING



COORDINATE MEASURING MACHINE (CMM)



2D VISION MEASURING SYSTEM



AUTOMATIC INSTANT MEASURING INSTRUMENT



ROUGHNESS MEASURING INSTRUMENT



DIGITAL MICROSCOPE

GRADES INTRODUCTION & PHYSICAL PROPERTIES



KNIVES & PARTS FOR CORRUGATED INDUSTRY

GRAIN SIZE	GRADE	ISO	DENSITY (g/cc)	HRA	HV	TRS(MPA)	RECOMMENDED APPLICATION
ULTRA-FINE GRAIN	GS25SF	K10	14.1	92.7	—	4500	Suitable for precision slitting applications, sub-micron WC grain size effectively suppresses edge defects and makes it easier to achieve excellent cut quality. It is characterized by long life and high wear resistance. Widely used in the processing of lithium batteries, metal foils, films, and composite materials.
	GS05UF	K05	14.8	93.5	—	3000	
	GS05U	K05	14.8	93.0	—	3200	
	GS10U	K20	14.7	92.5	—	3300	
	GS20U	K20	14.4	91.7	—	4000	
	GS26U	K30	14.1	90.5	—	4300	
	GS30U	K40	13.9	90.3	—	4100	
FINE GRAIN	GS05K	K05	14.9	92.3	—	3300	A versatile carbide grade that combines excellent wear resistance and anti-chipping performance, used in industries such as paper, chemical fibers, and food.
	GS10N	P20	14.7	91.3	—	2500	
	GS25K	K10	14.3	90.2	—	3800	
	GS30K	K40	14.0	89.1	—	3500	
MEDIUM GRAIN	GS05M	K10	14.9	91.0	—	2800	A medium grain, general-purpose carbide grade. Suitable for making wear-resistant parts and carbide tools used in conjunction with steel knives, such as bottom knives in rewinding machines.
	GS25M	K20	14.3	88.8	—	3000	
	GS30M	K30	14.0	87.8	—	3500	
	GS35M	K40	13.7	86.5	—	3200	
COARSE GRAIN	GS30C	K30	14.0	86.4	—	3200	A carbide grade with high impact strength, suitable for making shredding knives used in the plastics and rubber industries.
	GS35C	K40	13.7	85.5	—	3000	
FINE GRAIN CERMET	SC10	—	6.4	91.5	1550	2200	TiCN-based cermet grade. Lighter, density only half as much as standard WC-based carbide. It has excellent wear resistance and low metal affinity, making it suitable for producing tools used in machining metals and composite materials.
	SC20	—	6.4	91.0	1500	2500	
	SC25	—	7.2	91.0	1500	2000	
	SC50	—	6.6	92.0	1580	2000	

*The above are standard grades. Custom grades have a minimum order quantity requirement. Please contact our sales team for details.

CORRUGATED SLITTER SCORER KNIFE

Corrugated slitter scorer knives are used for slitting and trimming corrugated cardboard on corrugating lines, in conjunction with online grinding wheels. In the early 2000s, Sichuan Shen Gong was the first in China to introduce carbide corrugated slitter scorer knives. Today, Shen Gong is a globally recognized manufacturer of these knives, supplying OEM products to many of the world's leading corrugator manufacturers. The company leads the market in both market share and quality.

ITEM	DIMENSION (OD-ID-T mm)	ITEM	DIMENSION (OD-ID-T mm)
1	Φ200-Φ122-1.2	8	Φ265-Φ112-1.4
2	Φ230-Φ110-1.1	9	Φ265-Φ170-1.5
3	Φ230-Φ135-1.1	10	Φ270-Φ168.3-1.5
4	Φ240-Φ32-1.2	11	Φ280-Φ160-1.0
5	Φ260-Φ158-1.5	12	Φ280-Φ202-1.4
6	Φ260-Φ168.3-1.6	13	Φ291-Φ203-1.1
7	Φ260-Φ140-1.5	14	Φ300-Φ112-1.2

*The above are standard types. For stock availability and custom product requests, please contact sales.

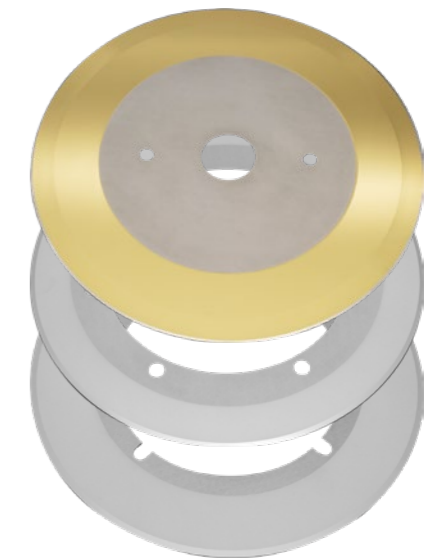

- Recommended carbide grades: GS26U/GS20U/GS25K
- Optional PVD coatings: TiN/TiCN/ZrN

ON-LINE SHARPENING WHEEL

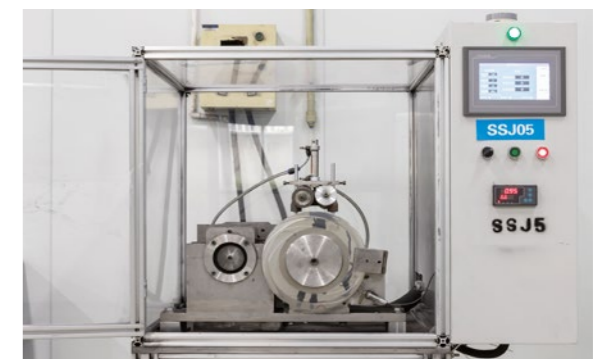

Shen Gong's supporting grinding wheels can quickly sharpen knives without causing damage, offering strong safety and reliability. Each batch of grinding wheels undergoes in-house simulated sharpening tests with knives before leaving the factory to ensure consistent performance.

FAQS ON USING CORRUGATED SLITTER SCORER KNIVES

ISSUE 1: RAPID KNIFE WEAR AND SHORT LIFESPAN

- 01. Extended Knife Sharpening Time:** This leads to unnecessary wear during sharpening.
- 02. Short Sharpening Intervals:** Frequent sharpening is required.
- 03. High Sharpening Pressure in the Grinder:** Excessive pressure can lead to knife breakage or wheel damage.
- 04. Coarse Diamond Grit on the Grinding Wheel:** This results in a rough edge, causing the knife to wear out quickly.

ISSUE 2: SLITTING CAUSES CRUSHED OR RAGGED EDGES ON THE CORRUGATED BOARD

- 01. Dull Blade:** The edge is not properly sharpened.
- 02. High Humidity or High Sand Content in the Corrugated board:** This affects the cutting quality.
- 03. Insufficient Tension in the Corrugated board:** The knife may not fully engage with the corrugated board, causing uneven cuts.

ISSUE 3: KNIFE BREAKAGE

- 01. Breakage During Sharpening:** This is often due to a damaged bearing on the grinding wheel shaft, causing the wheel to wobble. A slight wobble can cause serrated edge defects, while a large wobble can lead to knife breakage due to excessive impact.
- 02. Immediate Breakage of New knife:** Check the assembly of the grinding wheel, the proper adjustment and fastening of the blade holder, and whether the sharpening pressure is too high.
- 03. Excessive Slitting Resistance:** This can sometimes result in S-shaped cuts on the corrugated board edges, and in severe cases, cause knife breakage. High-weight corrugated board requires thicker knife to ensure sufficient blade strength.
- 04. Accidental Knives Impact:** This can occur if there is a metal foreign object on the corrugated board or a foreign object on the cutting base. Additionally, if the knife holder is not lifted during slitter machine setup, it can lead to knife breakage.



KNIVES FOR PACKAGING/PRINTING/PAPER PROCESSING INDUSTRIES

PACKAGING BOX SLOTTING BLADES

Slotting blades for packaging hard board, used in left-right pairs.

ITEM	DIMENSION (L*W*T mm)	RECOMMENDED GRAD
1	50*12*T	GS05U/GS20U
2	50*15*T	GS05U/GS20U
3	50*16*T	GS05U/GS20U

*The above are standard types. For custom product requests, please contact sales.

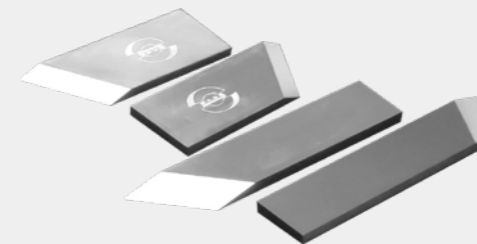

ART KNIFE BLADE

Made from highly wear-resistant carbide material, these art knife blades are designed for everyday cutting tasks. They offer several times longer lifespan and improved cutting quality.



TAPE SLITTING CIRCULAR KNIFE



OTHER KNIVES FOR THE PACKAGING INDUSTRY

Shen Gong can develop suitable knives based on the specific needs of the customer. For more details, please contact our sales team.

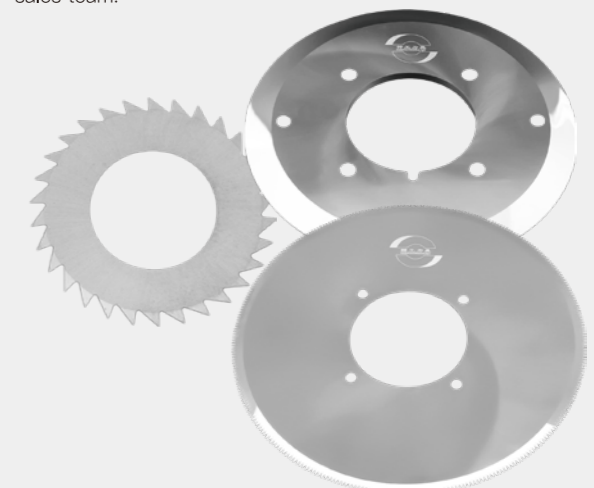

CORRUGATED CROSS-CUTTING KNIFE SERIES

- Corrugated Cross-Cutting Straight Knives and Corrugated Cross-Cutting Helical Knives.
- Options include solid high-speed steel, inlaid high-speed steel, solid powdered high-speed steel, and inlaid imported powdered high-speed steel.



ITEM	UPPER KNIFE DIMENSION (L*W*T mm)	LOWER KNIFE DIMENSION (L*W*T mm)	MACHINE TYPE
1	2240*30*8	2540*30*8	BHS
2	2591*32*7	2593*35*8	FOSBER
3	2591*37.9*9.4/8.2	2591*37.2*10.1/7.7	FOSBER
4	2506.7*25*8	2506.7*28*8	AGNATI
5	2641*31.8*9.6	2641*31*7.9	MARQUIP
6	2315*34*9.5	2315*32.5*9.5	TCY
7	1900*38*10	199*35.5*9	HSIEH HSU
8	1900*41.5*8	1900*39*8	CHAMPION
9	2280*38*13	2280*36*10	K&H

*The above are standard types. For custom product requests, please contact sales.

BOOK BINDING SHREDDER HEADS

Carbide heads used for book binding manufacturing process, installed on a shredder cutter. The slots or screw holes on the heads allow for quick changes.

ITEM	DIMENSION (L*W*T mm)	RECOMMENDED GRAD
1	21.15*18*2.8	GS25K
2	32*14*3.7	GS25K
3	50*15*3	GS25K
4	63*14*4	GS25K
5	72*14*4	GS25K

*The above are standard types. For custom product requests, please contact sales.



PRINTING SAW BLADES

Saw blades for book binding.



DRAG BLADES & OSCILLATING BLADES

Drag blades and Oscillating blades are used in the advertising industry for cutting materials such as KT boards, cardboard, PVC, acrylic, leather, and fabrics. They are installed on digital cutter machines. Shen Gong blades utilize high-strength, anti-chipping carbide materials, effectively reducing abnormal blade breakage during the cutting process.

ITEM	DIMENSION (L*W*T mm/ΦD*L mm)	PART NO.
1	50*8*1.5	Z13
2	25*5.5*0.63	Z16
3	28*4*0.63	Z21
4	28*6.3*0.63	Z42
5	Φ6*25	BLD-SR6150
6	Φ6*39	BLD-SR6223
7	Φ8*40	BLD-DR8160

*The above are standard types. For custom product requests, please contact sales.

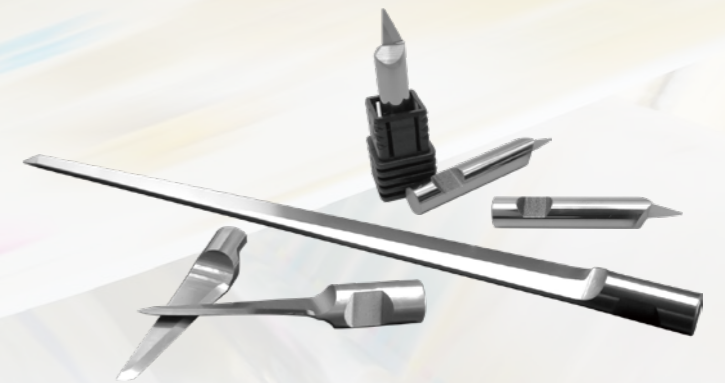

OTHER KNIVES FOR THE PRINTING INDUSTRY



CIGARETTE FILTER & STRAW CUTTING KNIVES

Circular slitting knives used for cutting cigarette filters, paper tubes, straws, and similar items. Shen Gong's unique carbide pressing and sintering technology effectively reduces the product thickness. Fresh sintering results in greater toughness.



ITEM	DIMENSION (L*W*T mm)	RECOMMENDED GRADE
1	Φ 88*Φ 16*0.26	GS20U/GS26U
2	Φ 89*Φ 15*0.3	GS20U/GS26U
3	Φ 90*Φ 15*0.3	GS20U/GS26U
4	Φ 100*Φ 15*0.15	GS20U/GS26U
5	Φ 100*Φ 15*0.3	GS20U/GS26U
6	Φ 100*Φ 45*0.2	GS20U/GS26U

*The above are standard types. For custom product requests, please contact sales.

MAGAZINE PROCESSING CUTTER

Solid carbide, used in left-right pairs.

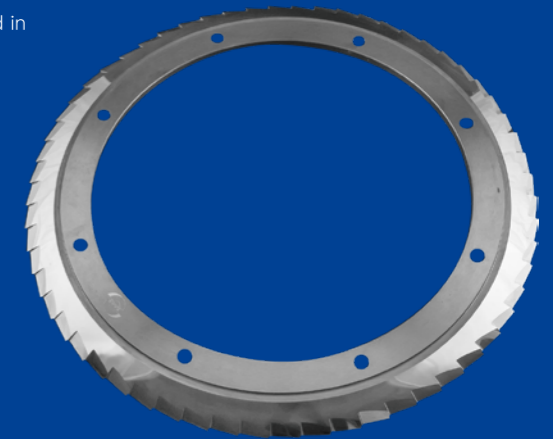

CROSS-CUTTING KNIVES FOR PAPER INDUSTRY

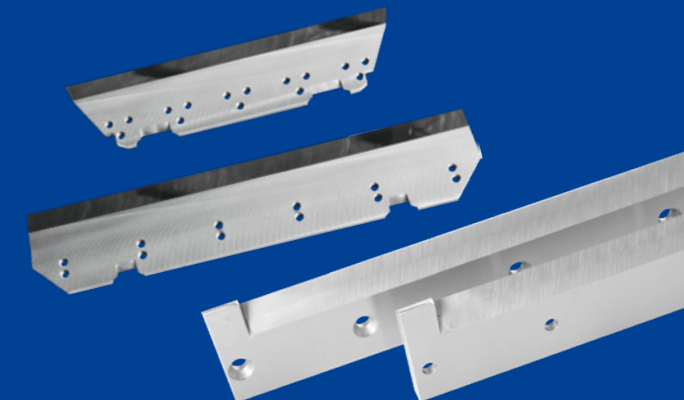

KNIVES FOR REWINDING MACHINES

Knives for rewinding machines used for slitting paper, film, foil, and other materials. The upper knife and lower knife are used together. The upper knife is made of high-speed steel, while the lower knife typically features an edge inlaid with carbide or is made solid carbide. Shen Gong's patented precision hot inlay technology effectively ensures the stability of the cutting edge ring.

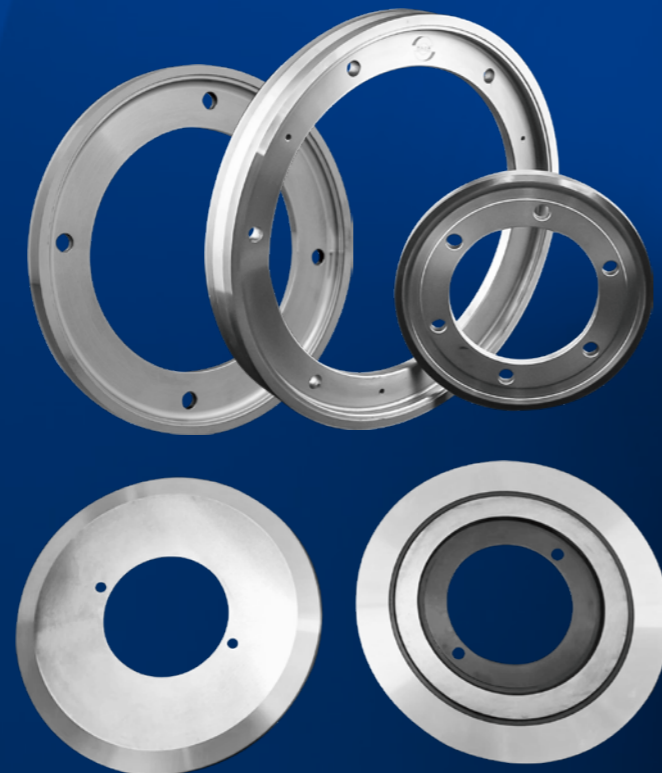

KNIVES & PARTS FOR LI-ION BATTERY INDUSTRY

SLITTING KNIVES FOR LI-ION BATTERY ELECTRODE SHEETS

Precision slitting circular knives for cutting electrode sheets of automotive power lithium-ion batteries and consumer electronics lithium-ion batteries. These knives are used in pairs, with an upper and lower blade. They are typically made from high-quality carbide grades with excellent wear resistance and anti-chipping performance. Custom options are available, including TiCN-based cermet or diamond-like coated blades, which reduce edge sticking (cold welding) and provide superior cutting quality and longer lifespan.

- High-density carbide material.
- Micron-level precision edge defect control, reducing burrs.
- Micron-level flatness machining technology ensures stable quality.
- Precision edge band grinding technology to suppress sticking (cold welding).
- Optional TiCN cermet or diamond-like coatings.



ITEM	DIMENSION (L*W*T mm)	NOTE
1	130*88*1.0	Upper knife
	130*70*3.0	Bottom knife
2	130*97*1.0	Upper knife
	130*95*4.0	Bottom knife
3	110*90*1.0	Upper knife
	110*90*3.0	Bottom knife
4	100*65*0.7	Upper knife
	100*65*2.0	Bottom knife
5	95*65*0.5	Upper knife
	95*55*2.7	Bottom knife

*The above are standard types. For custom product requests, please contact sales.



AUTOMATIC EDGE DEFECT DETECTION MACHINE FOR CIRCULAR KNIVES

Based on years of experience in the production and inspection of precision slitting circular knives, Shen Gong offers an edge defect detection machine for circular knives. This machine automatically and quickly identifies edge defects, quantifies the defect size, and generates judgment results simultaneously. It helps users effectively monitor blade usage during actual production, ensuring cutting quality.

- Quick detection.
- Compatible with most models and sizes of slitting circular knives in the industry.
- Easy to use, with a simple and intuitive interface.

SLITTING KNIFE HOLDERS

Shen Gong offers customized slitting knife holders with traditional Japanese-style structures for power batteries, digital batteries, and energy storage batteries. Additionally, Shen Gong provides its self-developed cantilever quick-change slitting knife holders, featuring advantages such as quick single-knife replacement, high precision retention, and digital-control adjustment.

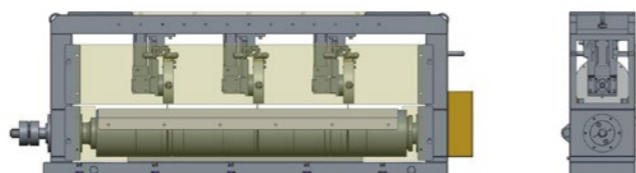

LITHIUM-ION BATTERY ELECTRODE SHEET WINDING CROSS-CUTTING KNIFE

Used for slitting and cross-cutting of battery electrode sheets during winding. The moving knife and fixed knife are used with a high-precision knife holder. Both the moving and fixed knife edges are made from high-quality carbide grades with excellent wear resistance and anti-chipping performance. Special precision edge treatment effectively suppresses powdering, ensuring battery cell capacity and achieving superior electrode sheet cut quality.

ITEM	DIMENSION (L*W*T mm)	NOTE
1	255-39-5	Cutting knife (left)
	255-39-5	Cutting knife (right)
2	300-24-15	Anvil knife
3	358-24-15	Anvil knife (left)
	358-24-15	Anvil knife (right)

*The above are standard types. For custom product requests, please contact sales.

- High-density, high-strength carbide material.
- 300x magnification inspection for edge defect control.
- Micron-level flatness control for the moving knife.
- Micron-level edge straightness control for the fixed knife.
- Specially treated edges to enhance anti-chipping performance and suppress powdering.
- Options for either fully carbide knives or carbide-edged knives.
- DLC coating available.



KNIVES HOLDER FOR CROSS-CUTTING KNIFE

We offer customized design and production services for knife holders compatible with electrode sheet winding cross-cutting knives.

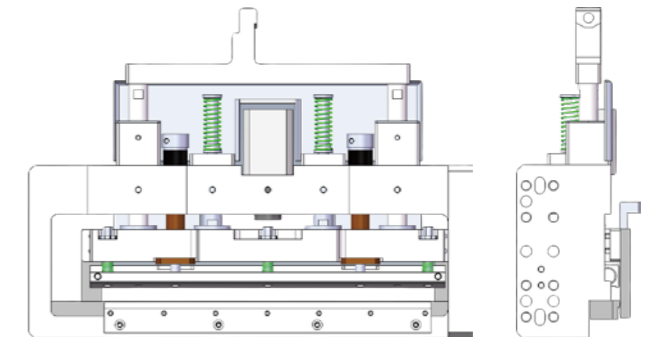

OTHER PRODUCTS FOR THE LITHIUM-ION BATTERY INDUSTRY

Battery separator razor blades, serrated cutting knives, adhesive tape cutting knives, rotary knives, spacers, and other products.



KNIVES FOR METAL SHEET AND FOIL INDUSTRIES

COIL SLITTING KNIVES

Coil slitting knives are suitable for slitting materials such as electrical silicon steel sheets, stainless steel sheets, high-strength automotive sheets, and non-ferrous metal sheets. They are widely used in industries such as automotive, electronics, and new energy.

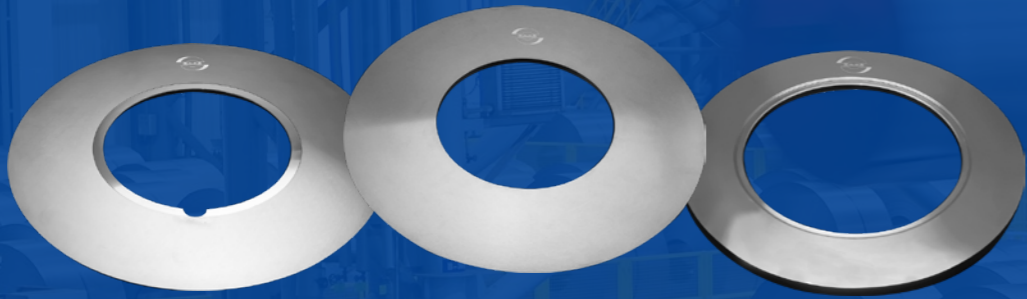

- Micron-level parallelism, flatness, and thickness accuracy control.
- Micron-level edge defect control.
- Dimensional accuracy consistency control.

ITEM	DIMENSION (L*W*T mm)	RECOMMENDED GRADE
1	Φ 200*Φ110*30	GS26U/GS30M
2	Φ 240*Φ120*3	GS26U/GS30M
3	Φ 280*Φ160*5	GS26U/GS30M
4	Φ 310*Φ180*5/10	GS26U/GS30M
5	Φ 320*Φ200*5	GS26U/GS30M

*The above are standard types. For custom product requests, please contact sales.



SLITTING GANG KNIVES FOR METAL SHEET

Slitting gang knives for metal sheet used in the electronics and new energy industries. They can slit silicon steel sheets, nickel sheets, aluminum foil, stainless steel sheets, copper sheets, and films (tab tapes).

ITEM	DIMENSION (L*W*T mm)	RECOMMENDED GRADE
1	Φ130*Φ60*T	GS26U
2	Φ130*Φ66.68*T	GS26U

*The above are standard types. For custom product requests, please contact sales.



CARBIDE SAW BLADES FOR METAL PROCESSING

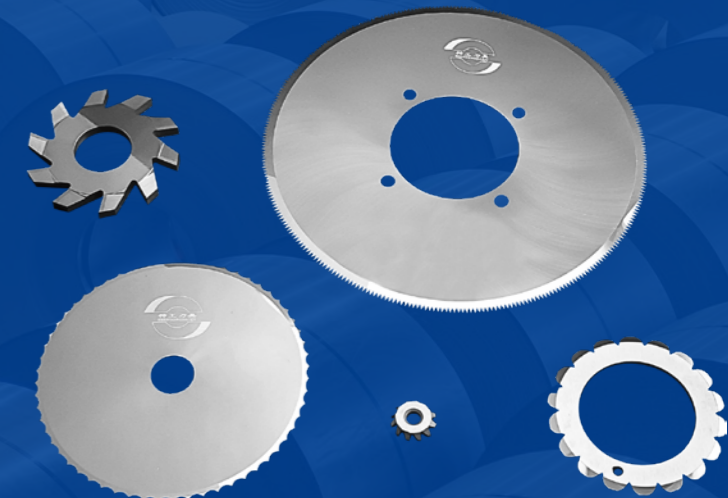



COPPER AND ALUMINUM FOIL SLITTING CIRCULAR KNIVES

- Utilizing unique edge grinding technology, the blade edges are smooth and free of nicks, effectively suppressing dust and burr issues.
- High-density, high-strength carbide material ensures edge strength.
- Optional high-hardness diamond-like coating enhances longevity and reduces chemical affinity with the materials being slit.

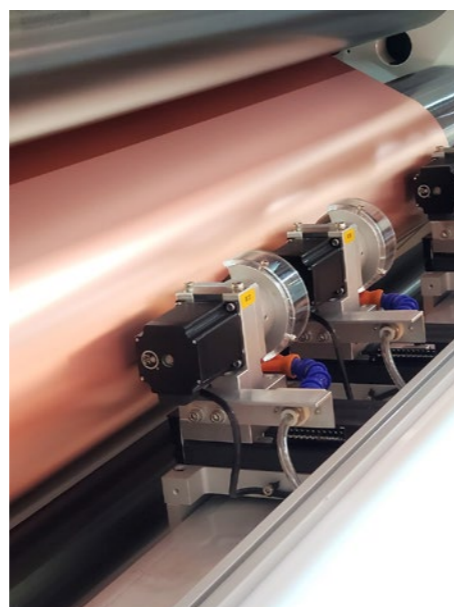

ITEM	DIMENSION (L*W*T mm)	RECOMMENDED GRADE
1	Φ50*Φ20*0.3	GS26U/GS20U
2	Φ80*Φ20*0.5	GS26U/GS20U
3	Φ80*Φ30*0.3	GS26U/GS20U
4	Φ80*Φ30*0.5	GS26U/GS20U
5	Φ80*Φ30*1.0	GS26U/GS20U

*The above are standard types. For custom product requests, please contact sales.

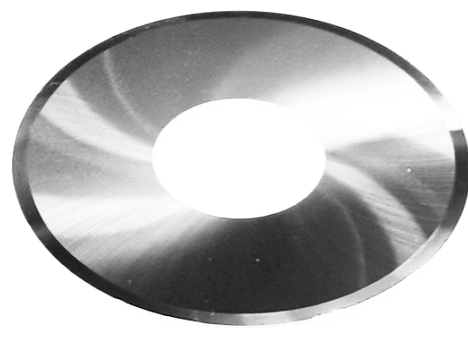
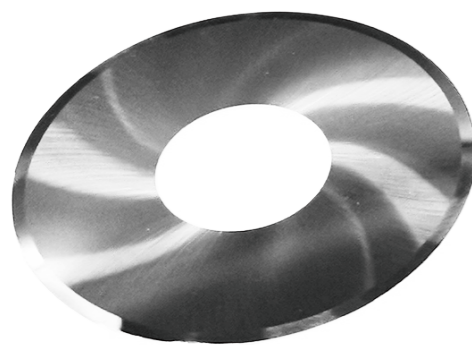

KNIVES FOR RUBBER&PLASTIC AND RECYCLING INDUSTRIES

PLASTIC GRANULATOR ROTARY AND FIXED BLADES

Granulator blades are used for cutting and granulating in the plastic industry. Multiple rotary blades are installed on the roller and work in conjunction with the fixed blade. Shen Gong offers both welded and quick-change insert-type rotary blades.

- Selection of chipping-resistant carbide grades, beneficial for multiple regrinds
- Complex groove machining capability
- Straightness control
- Edge defect control
- Optional solid carbide threads or welded steel threads

ITEM	DIMENSION (L*W*T mm)	NOTE
1	68.5*22*4	Insert-type rotary blade
2	70*22*4	Insert-type rotary blade
3	79*22*4	Insert-type rotary blade
4	230*22*7/8	Welded-type rotary blade
5	300*22*7/8	Welded-type rotary blade
6	100*30*10	Fixed Blade
7	200*30*10	Fixed Blade
8	235*30*10	Fixed Blade

*The above are standard types. For custom product requests, please contact sales.



SHREDDER (CRUSHER) ROTARY KNIFE

Shredder (crusher) rotary knives are blades used for recycling in industries such as plastics, rubber, and chemical fibers. The blades are secured to the rotary knife shaft with screws and work in conjunction with the fixed knives to crush and shred materials. Available options include solid carbide rotary knives (with threading), welded-thread carbide rotary knives, long welded carbide rotary knives, tool steel rotary knives, and PVD-coated rotary knives.

ITEM	DIMENSION (L*W*T mm)	NOTE
1	38.2*38.2*12	1-Φ12.8
2	40*40*12	1-Φ14
3	40*40*20	-
4	43*43*19.5	Φ13
5	43.2*43.2*19.5	Φ13
6	55*55*25	-
7	60*60*20	Welded screw

*The above are standard types. For custom product requests, please contact sales.

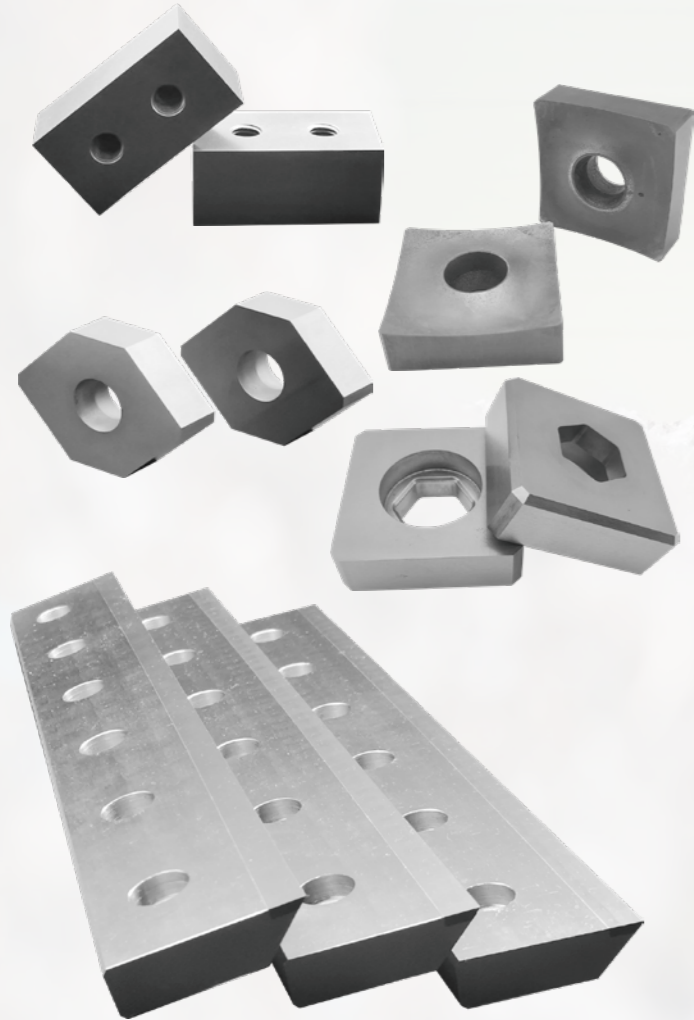

SHREDDER (CRUSHER) FIXED KNIFE

The fixed knife in the shredder features an edge welded with highly wear-resistant carbide material and is used in conjunction with the rotary knife. It is suitable for the crushing needs of various materials.



PINVENT TRIMMERS

Blades used for trimming rubber columns on tire treads caused by mold vent holes after tire manufacturing.

- Solid carbide for longer lifespan
- Automatic precision grooving with guaranteed dimensional consistency

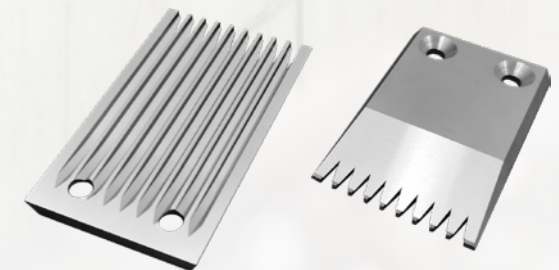



KNIVES FOR CHEMICAL FIBER & NON-WOVEN FABRIC INDUSTRIES



KNIVES FOR FOOD PROCESSING

CHEMICAL FIBER CUTTING BLADES

ITEM	DIMENSION (L*W*T mm)	RECOMMENDED GRADE
1	74.5*15.5*0.884	GS25K
2	95*19*0.9	GS25K
3	135.5*19.05*1.4	GS25K
4	140*19*0.884	GS25K
5	170*19*0.884	GS25K

*The above are standard types. For custom product requests, please contact sales.

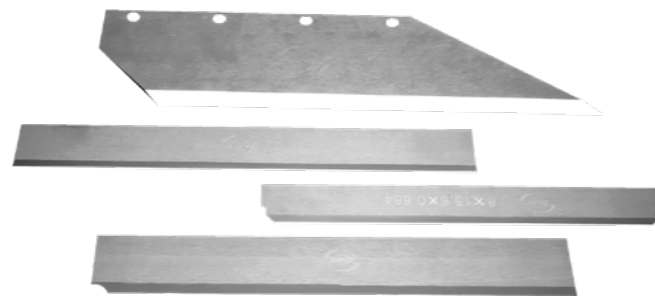

MEAT PROCESSING ROUND KNIVES



WET WIPE CUTTING KNIVES



TEXTILE INDUSTRY OTHER BLADES



FOOD INDUSTRY GRINDER BLADES





KNIVES FOR MEDICAL INDUSTRY

KNIVES AND BLADES FOR MEDICAL DEVICE

Shen Gong's products consistently use pure virgin materials, enabling the production of various high-quality medical device processing knives and blades. RoHS and REACH reports are available upon request.

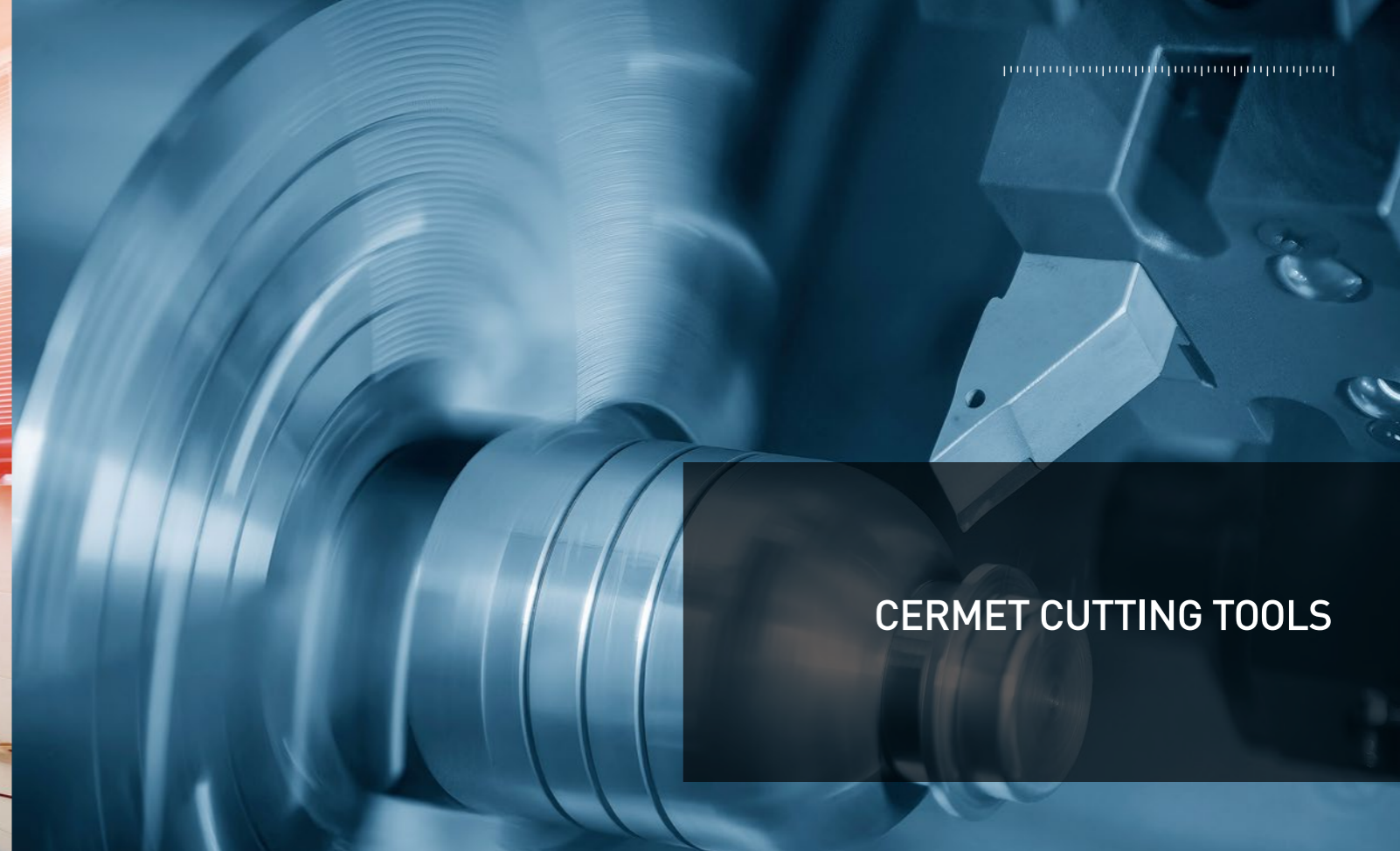
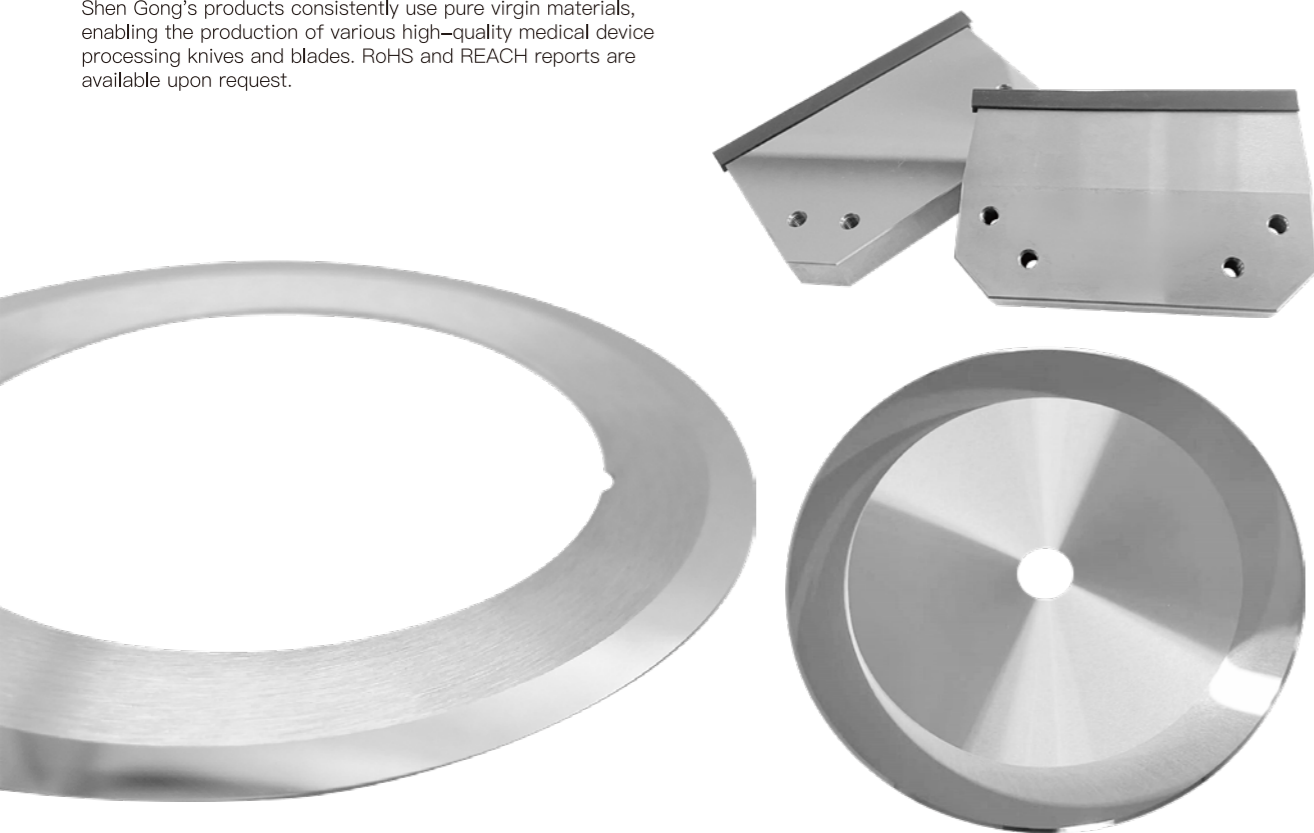

CERMET CUTTING TOOLS

JAPANESE TECHNOLOGY CERMET MATERIALS

TiCN-based cermet is a composite powder metallurgy material made using titanium carbonitride (TiCN) and other carbides as the hard phase. It has the advantages of being lightweight (lighter than standard steel), having low metal affinity (less prone to chemical reactions), and high wear resistance. It is an ideal material for manufacturing precision machining tools.

Sichuan Shen Gong's cermet production line was developed over several years by a team led by Japanese engineers. The technology, production equipment, and inspection equipment are all fully benchmarked against those of leading Japanese companies.

Current products include cutting inserts, saw tips, slitting blades, and die profiles. Custom cermet tools can also be developed based on customers' specific operating conditions.

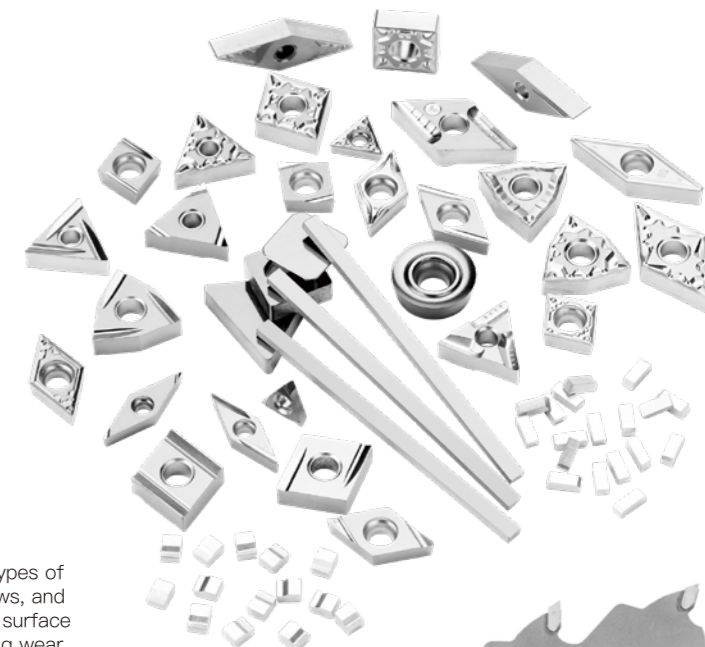

CERMET SAW TIPS

Cermet tips for metal working saw blades. Suitable for various types of metal cutting saw blades, including machine cold saws, hand saws, and power tools. Shen Gong's cermet saw blade tips feature a good surface soldering layer, excellent toughness, and superior self-sharpening wear resistance.



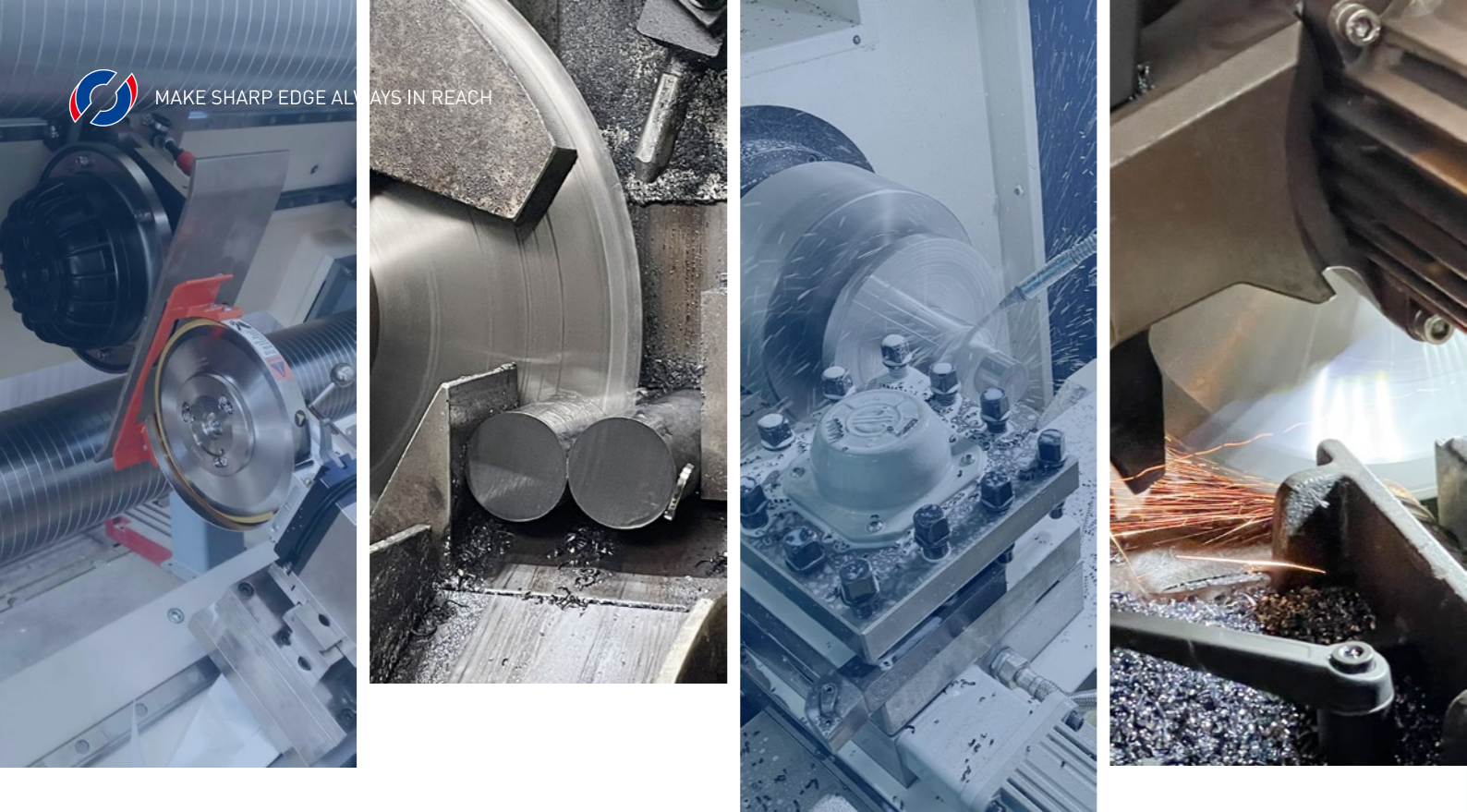

CARBIDE BLANKS

CARBIDE AND CERMET BLANKS

Carbide and cermet profiles suitable for further processing. These include sheets, strips, discs, rings, rods, and special-shaped tool tips. Ideal for the subsequent production and manufacturing of molds, wear-resistant parts, tools, and other products.

- A complete range of grades, widely used in various products and industries.
- Comprehensive pressing and sintering equipment, covering a wide range of shapes and sizes.
- Unique material sintering and post-processing techniques result in fewer defects during further processing.



CERMET INDEXABLE CUTTING INSERTS

Indexable CNC inserts for semi-finishing to finishing operations on materials such as carbon steel, alloy steel, and stainless steel. Products include ground inserts, non-ground inserts, insert blanks, and custom non-standard inserts. Shen Gong's current cermet grades meet the requirements for various applications, including turning, milling, reaming, and parting.

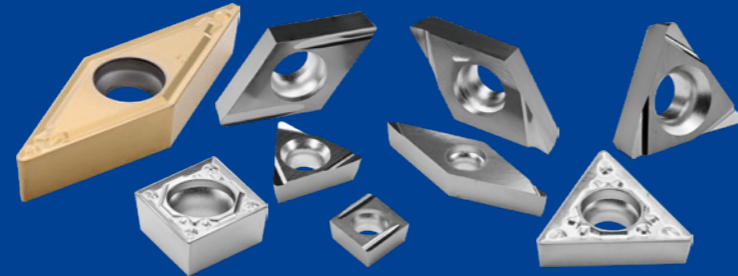

CERMET PRECISION SLITTING KNIVES

Cermet blades suitable for precision slitting of non-ferrous metals. Compared to traditional carbide slitting blades, they offer the "3L" advantages: Lighter, Less Metal-Sticking, and Longer Life-span.



OTHER CUSTOMIZED PRODUCTS

CUSTOMIZED PRODUCTS

Shen Gong has a complete production line for carbide industrial knives and blades, from powder to finished products. Whether it's materials or products, we have the capability for customized development. Please feel free to contact Shen Gong's sales team to customize your non-standard products.



OUR SERVICE

Shen Gong's professional technical and sales team possesses extensive experience and application knowledge in the industrial knife industry. We are capable of working closely with customers to conduct in-depth research and improvements on technical issues. Whether it's installation and commissioning or solution design, Shen Gong is committed to continuous innovation and excellence to meet the most precise production needs.

SHEN GONG OFFERS THE FOLLOWING SERVICES

- Measurement and mapping of sample geometries, with 3D models available if necessary.
- Testing of the physical properties and chemical composition of sample materials, with CNAS-certified reports available if necessary.
- Blade refurbishment services (for a fee).
- Blade trade-in services for new blades.
- Technical consultation and one-stop solutions for industrial knives and blades.
- Professional after-sales service support from industrial knife engineers.

神工在手 分切无忧
Make Sharp Edge Always In Reach

SINCE 1998